

Note: Max. Water Depth = 16 1/2"

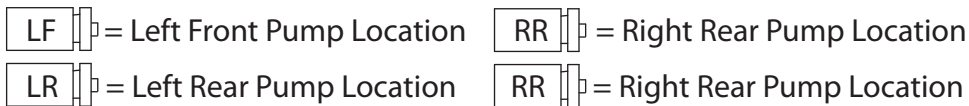
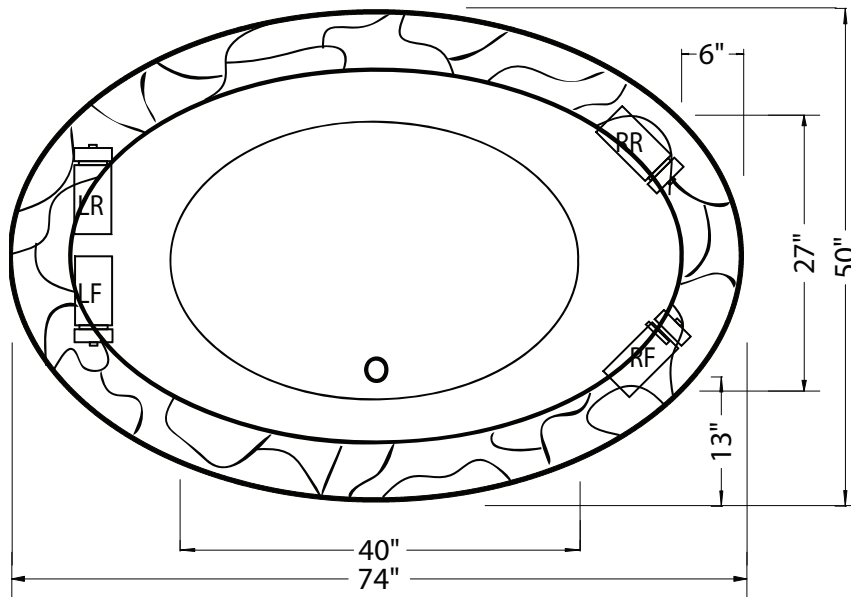

**MODEL:** WAVE

**SIZE:** 50" x 74"

**AVERAGE FILL (GAL):** 80 GALLONS

**ELECTRICAL REQUIREMENT:** 110V 20 AMP CIRCUIT

**WATER JETS (WHIRLPOOL):** 4 ADJUSTABLE, 4 PULSATING

**WATER JETS (THERAPY WP):** 4 ADJ, 2 PULSE, 6 SPINNING MICROJET

**AIR JETS (AIR BATH):** 24 AIR INJECTOR JETS

**INSULATION:** R-15 SPRAY FOAM (OPTIONAL ON SOAKER)

**INLINE HEATER:** OPTIONAL 110V (N/A ON AIR BATH)

**LIGHTING SYSTEM:** OPTIONAL LED SPA LIGHT

### NOTES:

Also available: Whirlpool/Air combo, Therapy/Air combo, Whirlpool/Turbo Air combo, Therapy/Turbo Air combo

Whirlpool and Therapy Whirlpool adds 1.5" to overall height

Air Bath, and combination Whirlpool/Air adds 3" to overall height

Inline heater requires additional 20 Amp 110v GFCI circuit

Deck cutout dimensions should be 2" smaller than tub dimensions

Controls will be surface mounted near the desired pump location

Soaker

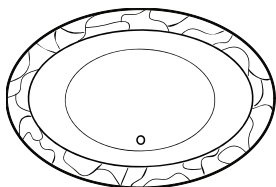

Whirlpool

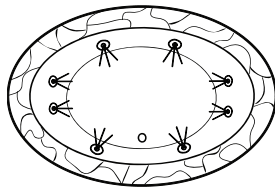

Therapy Whirlpool

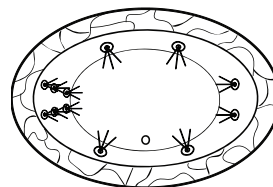

Air Bath

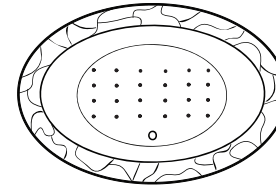

### LEGEND:

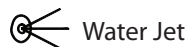

Water Jet



Air Jet

IZZI BATH  
12950 N Hwy 27  
Clermont, FL 34715  
(800) 214-7440  
www.izzibath.com