

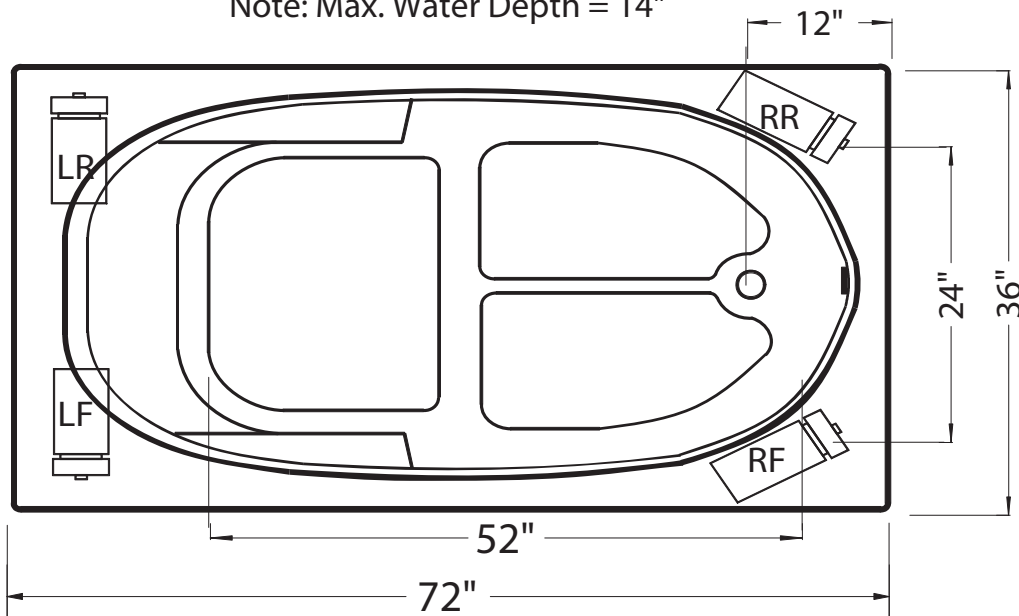



Note: Max. Water Depth = 14"



-  = Left Front Pump Location
-  = Right Front Pump Location
-  = Left Rear Pump Location
-  = Right Rear Pump Location

MODEL: NB406

SIZE: 36" x 72"

AVERAGE FILL (GAL): 60 GALLONS

ELECTRICAL REQUIREMENT: 110V 20 AMP CIRCUIT

WATER JETS (WHIRLPOOL): 4 ADJUSTABLE, 1 PULSATING

WATER JETS (THERAPY WP): 4 ADJUSTABLE, 6 SPINNING MICROJET

AIR JETS (AIR BATH): 20 AIR INJECTOR JETS

INSULATION: R-15 SPRAY FOAM (OPTIONAL ON SOAKER)

INLINE HEATER: OPTIONAL 110V (N/A ON AIR BATH)

LIGHTING SYSTEM: OPTIONAL LED SPA LIGHT

NOTES:

Also available: Whirlpool/Air combo, Therapy/Air combo, Whirlpool/Turbo Air combo, Therapy/Turbo Air combo

Whirlpool and Therapy Whirlpool adds 1.5" to overall height

Air Bath, and combination Whirlpool/Air adds 3" to overall height

Inline heater requires additional 20 Amp 110v GFCI circuit

Deck cutout dimensions should be 2" smaller than tub dimensions

Controls will be surface mounted near the desired pump location

Soaker

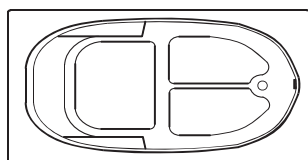

Whirlpool

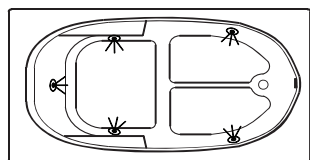

Therapy Whirlpool

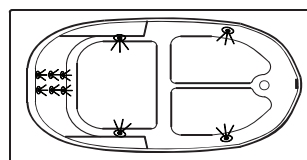

Air Bath

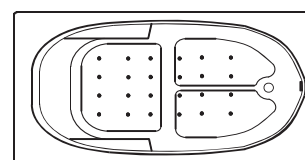

LEGEND:

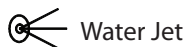

Water Jet



Air Jet

IZZI BATH
 12950 N Hwy 27
 Clermont, FL 34715
 (800) 214-7440
 www.izzibath.com